

# How to Use Your Cobra 29 LTD NIGHTWATCH

Features .....	1
The CB Story .....	A1
FCC Regulations	
FCC Warnings	
Included Accessories	
Controls & Indicators.....	A2
Our Thanks to You.....	A3
Customer Support	
Installation .....	
Location.....	2
Mounting and Connection.....	2
Antennas .....	
CB Antenna .....	6
Marine Installation.....	6
Ignition Noise Interference.....	7
Operating Your 29 LTD NIGHTWATCH .....	
Turning On Your CB .....	8
Setting Channel Selector .....	9
Calibrate For SWR (Standing Wave Ratio) .....	10
To Receive .....	12
Selecting a Channel .....	13
S-Meter .....	13
NB-ANL/ANL/Off (Noise Blanker/Automatic .....	14
Noise Limiter Switch)	
Tone Hi/Nor .....	15
RF Gain Control.....	15
Dimmer Switch.....	16
Setting Squelch .....	16
To Transmit.....	18
Setting Dynamike .....	18
Transmit .....	19
RF Meter .....	20
External Speaker .....	21
PA (Public Address).....	22
Home And Office Set-Up.....	24
Temporary Mobile Set-Up.....	25
CB 10 Codes.....	26
Frequency Ranges .....	28
29 LTD NIGHTWATCH Specifications .....	29
FCC Statement .....	30
Warranty Information.....	32
Product Service.....	33

## Features of This Product

- 40 CB Radio Channels
- Heavy-Duty Dynamic Microphone
- Full 4 Watts AM RF Power Output
- SWR Calibration Meter
- Instant Channel 19 and 9
- Front Panel 4-Pin Microphone Connector
- Antenna Warning LED
- Switchable Automatic Noise Limiter & Noise Blanker
- Adjustable Dynamike Boost
- Tactile Controls
- Illuminated Front Panel
- Dim Control
- RF Gain
- 9 ft. Mic Cord

## Location

### Location

Plan location of transceiver and microphone bracket before starting the installation.

Select a location that is convenient for operation, yet does not interfere with the driver or passenger.

The transceiver is usually mounted to the underside of the dash with the microphone bracket beside it.

## Mounting and Connection

### Note

The transceiver is held in the universal mounting bracket by two thumbscrews which allow for adjustment at a convenient angle.

The bracket includes two self-tapping screws and star washers. The mounting must be mechanically strong, conveniently located.

### Mounting and Connection

- 1 Hold the radio with the mounting bracket in the exact desired location. If there is no interference, remove the bracket and use it as a template to mark the location for the mounting screws.

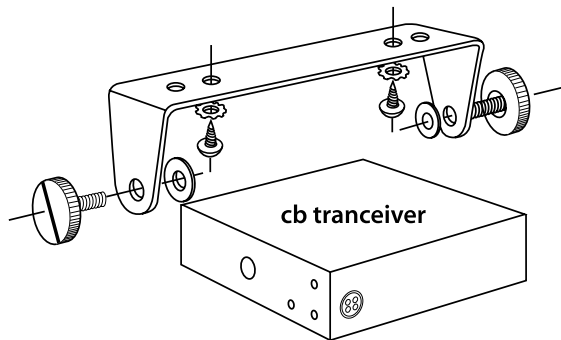

- 2 Drill the holes and secure the bracket.

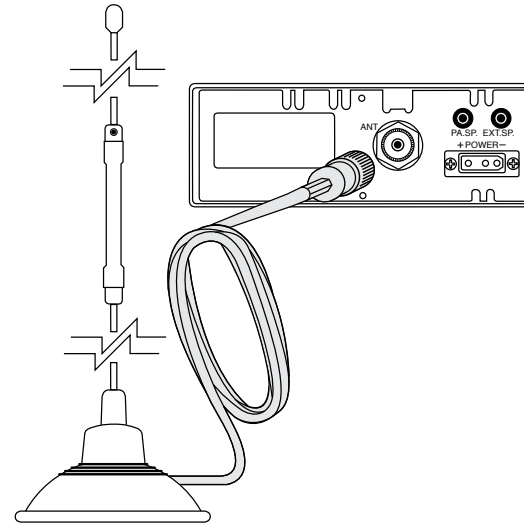

- 3 Connect the antenna cable plug to the receptacle marked "ANT" on the back of the unit.

continued

# Installation

## Note

For best performance, we recommend the radio be connected directly to the battery.

## Note

Before installing the CB radio, visually check the vehicle's battery connection to determine which terminal is positive or negative. A negatively grounded vehicle has its negative lead grounded to the chassis.

## Note

Connecting to an accessory fuse prevents the unit from being left on accidentally, and also permits operating the unit without running the engine.

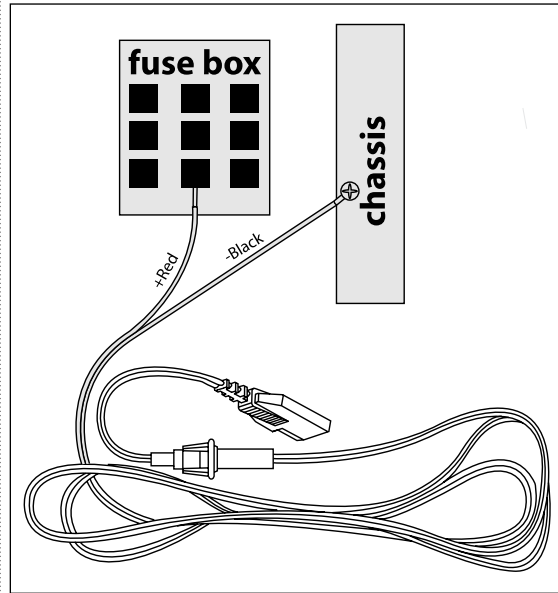

- 4 In a negative grounded vehicle, connect the red lead of the DC power cord to an accessory 12 volt fuse.
- 5 Connect the black lead to the negative side of the vehicle. This is usually the chassis. Any convenient location with a good electrical contact (remove paint) may be used.

# Installation

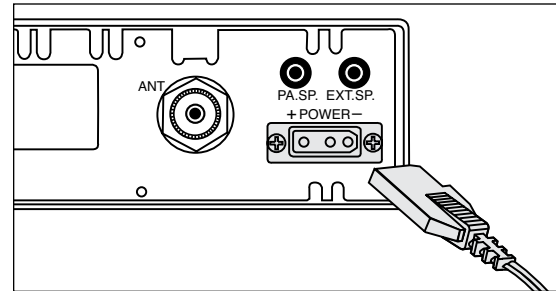

- 6 Plug power cable into back of unit marked "Power". Be sure to observe polarity markings.
- 7 Mount the microphone bracket on either side of the unit (driver's left) using two screws supplied. Bracket should be placed under the dash so microphone is readily accessible.

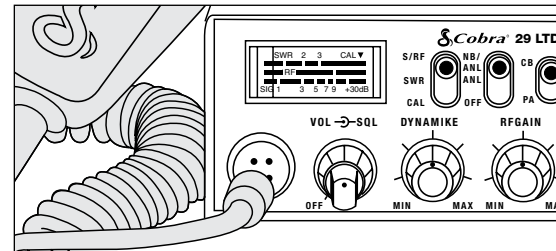
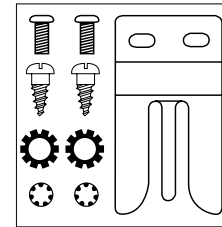

- 8 Attach the 4-pin microphone cable to receptacle on front of unit and install unit in bracket securely.

# Antennas

## CB Antenna

### Note

For optimum performance in passenger cars the ideal antenna location is on the center of the roof. Second choice is on the center of the trunk.

### Note

Because many newer trucks feature fiberglass door skins, the outside mirror must be grounded to the chassis via ground strap, if the antenna is mounted on the mirror bracket.

### Note

3-way Combination Antennas are also available which allow operation of all three bands (AM-FM & CB), using a single antenna. However, this type of antenna usually results in less than normal transmit and receive range when compared to a standard-type "Single Band" CB antenna.

## CB Antenna

Since the maximum allowable power output of the transmitter is limited by the FCC, the antenna is critical in affecting transmission distance. Only a properly matched antenna system will allow maximum power output. Cobra® loaded type antenna models are highly recommended for most installations. Consult your Cobra® dealer for further details, or visit our website: [www.cobra.com](http://www.cobra.com).

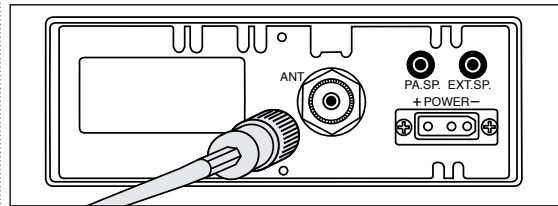

- 1 A standard antenna connector is provided on the transceiver for easy connection.

## Marine Installation

The transceiver will not operate at maximum efficiency in a boat without a ground plane, (unless it has a steel hull). Before attempting installation, consult your dealer for information regarding an adequate grounding system and prevention of electrolysis between fittings in the hull and water.

# Ignition Noise Interference

Use of a mobile receiver at low signal levels is normally limited by the presence of electrical noise. The primary source of noise in automobiles is from the alternator and ignition system. Typically, when signal level is adequate, the background noise does not present a serious problem. Also, when extremely low level signals are being received, the transceiver may be operated with the vehicle's engine turned off. The unit requires very little current and therefore will not significantly discharge the vehicle's battery.

Even though the Cobra 29 LTD NIGHTWATCH has an automatic noise limiter, in some installations ignition interference may be high enough to make good communications impossible. Many possibilities exist and variations between vehicles require different solutions. Consult your COBRA® dealer or a 2-way radio technician for help in locating the source of a severe noise.

## Turning On

### Turning On

Make sure the power cord, antenna and microphone are connected to their proper connectors before starting.

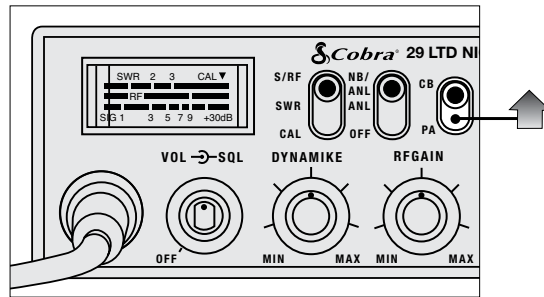

- 1 The  CB/PA button should be in the CB position.

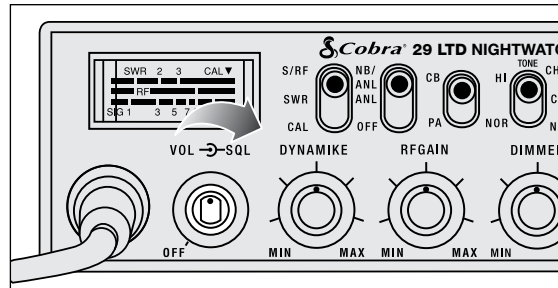

- 2 Rotate the On/Off Volume knob  clockwise to a normal listening level.

## Setting Channel Selector

## Setting Channel Selector

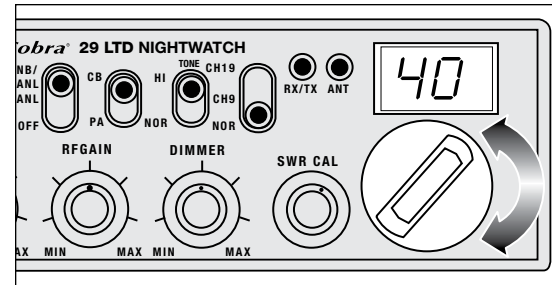

- 1 Select  one of forty channels and adjust volume. The selected channel is indicated by the LED readout directly above the channel selector knob

## Calibrate For SWR (Standing Wave Ratio)

### Calibrate for SWR (Standing Wave Ratio)

SWR calibration is required to accurately measure SWR on the built in meter. We suggest performing this calibration procedure before placing the meter function switch into the SWR position and anytime the antenna or coax cable is replaced to confirm antenna system performance.

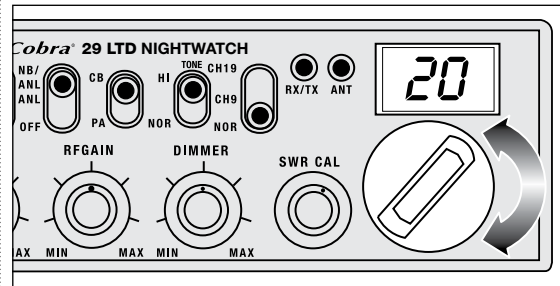

- 1 Select channel 20.

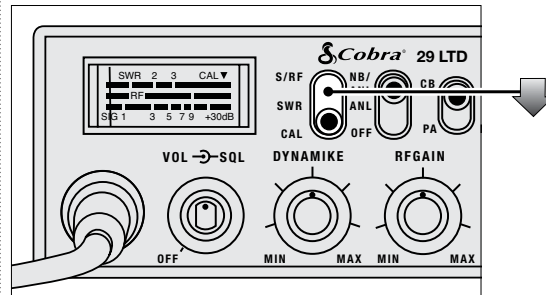

- 2 Switch to the CAL position.

**Note**

Antenna Indicator LED will illuminate when TX if SWR is high.

**PUSH & HOLD**

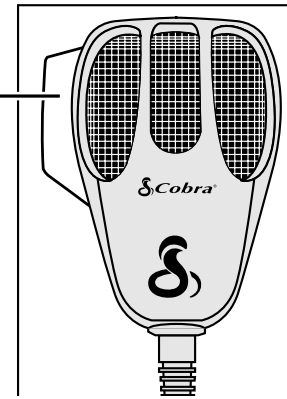

- 3 Push and hold mic button.

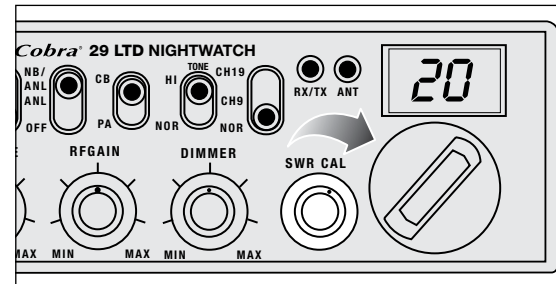

- 4 While holding mic button adjust the SWR CAL knob so the meter needle swings to the CAL mark on the meter (located on the right).

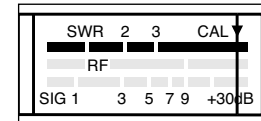

**Note**

Calibration must be made in an open area (never in a garage). Vehicle doors must be closed. No one should be standing near the antenna. (See your antenna directions for more complete information).

continued

# Operation

## Note

When switched to SWR position the meter needle should ideally be as far to the left as possible. Anything over 3 is not acceptable. A slight antenna height adjustment (higher or lower) may be required. Repeat recalibration steps.

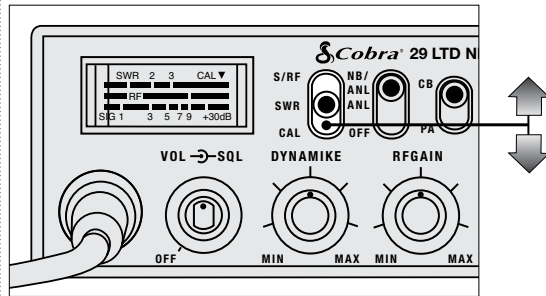

- While still holding down the mic button, set the S/R/F SWR CAL switch to the SWR position, to read the SWR reading.
- Repeat the same steps two through five on Channel 1 and 40. This will check SWR for all channels.

## To Receive

### To Receive

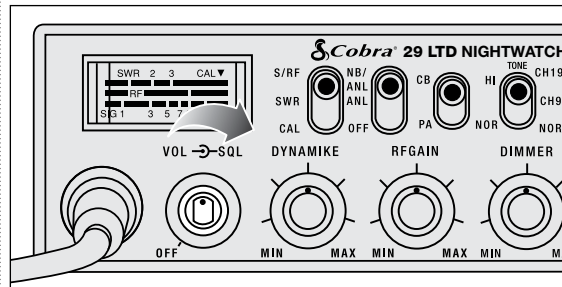

- Rotate the On/Off Volume knob clockwise the green RX/TX LED will be illuminated.

# Operation

## Selecting A Channel

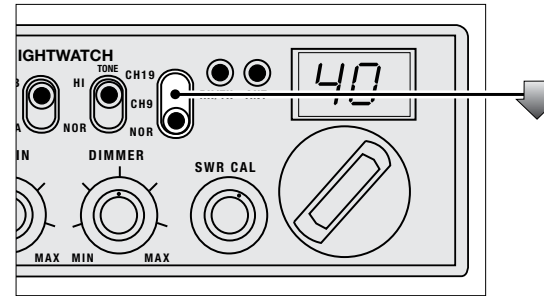

- Switch to NOR to select desired channel.

## S-Meter

Swings proportionately to strength of incoming signal when receiving.

## Selecting A Channel

### Note

Switch to 9 (Emergency) or 19 (Information) for instant access to these channels.

## S-Meter

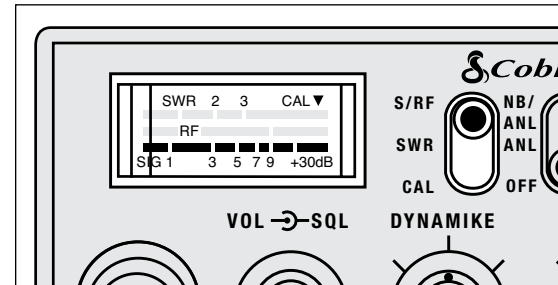

- The S/R-F-SWR-CAL switch must be in the S/R/F position to read the meter.

# Operation

## NB-ANL/ANL/OFF (Noise Blanker/Automatic Noise Limiter) Switch

### Note

The RF noise blanker is very effective in reducing impulse noises such as ignition interference.

NB-ANL/ANL/OFF (Noise Blanker/Automatic Noise Limiter) Switch

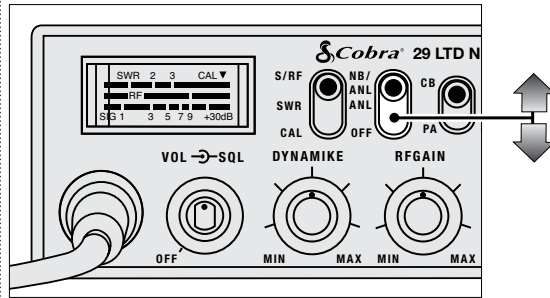

- 1 When switched to ANL the Automatic Noise Limiter is activated. This helps reduce noise created by the vehicle's electronics.

When switched to NB/ANL position the RF Noise Blanker is also activated, providing increased noise filtration.

When switched to OFF position all noise filtration will be turned off.

# Operation

## Tone Hi/Nor

### Tone Hi/Nor

This switch is used to shape the Audio Frequency Response to the operators preference.

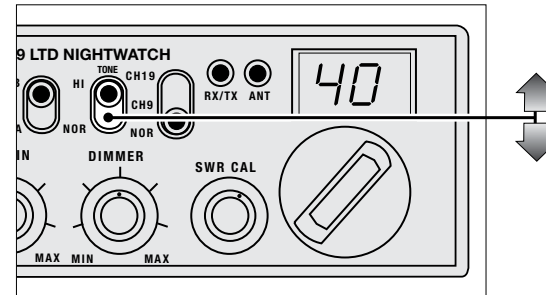

- 1 When set in HI the treble is increased.

### RF Gain Control

The RF Gain is used to optimize reception in strong or weak signal areas.

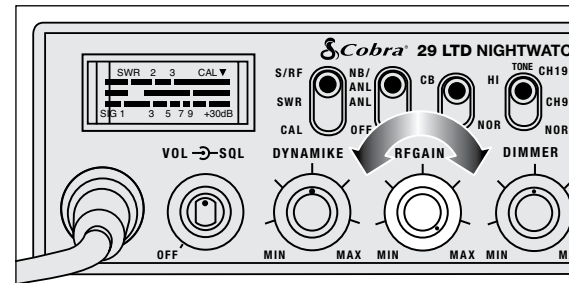

- 1 Rotate the RF Gain knob *counterclockwise* to reduce gain in strong signal areas. In weak signal areas turn *clockwise* to increase gain.

## RF Gain Control

### Note

The RF Gain is used to optimize reception in weak signal areas.



# Operation

## Bright/Dim Switch

### Note

The Dimmer controls the brightness of the front panel, signal strength meter and channel display.

### Dimmer Switch

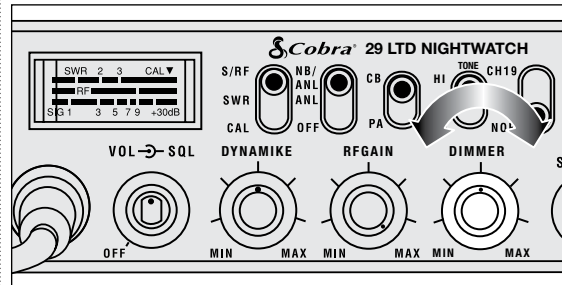

- 1 Rotate the Dimmer knob clockwise for maximum brightness; counter-clockwise for minimum.

## Setting Squelch

### Gate closed

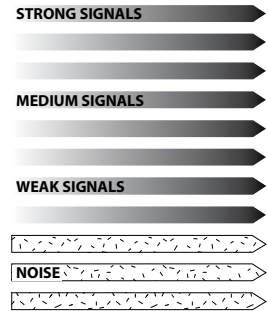

### Setting Squelch

Squelch is the “control gate” for incoming signals.

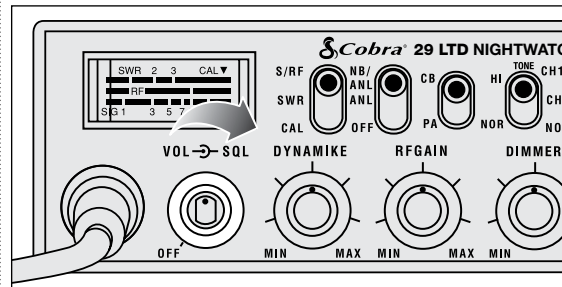

- 1 Full rotation closes the gate allowing only very strong signals to enter.

# Operation

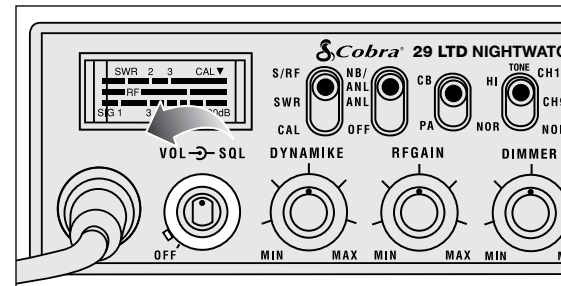

- 2 Full rotation opens the “gate” allowing all signals in.

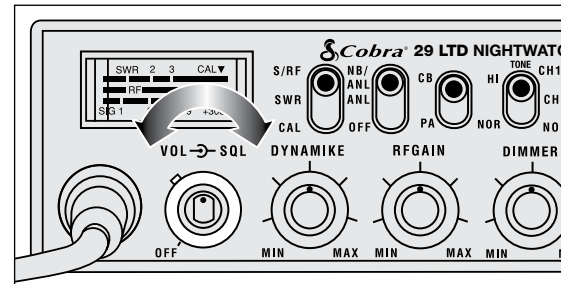

- 3 To achieve the Desired Squelch Setting (DSS), turn the Squelch control until you hear noise. Now turn the control just until the noise stops. This is the DSS setting.

### Gate open

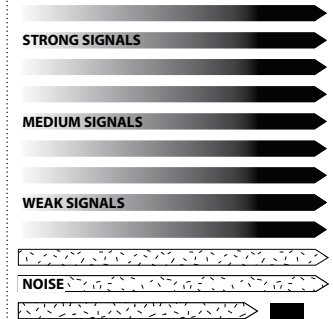

### Gate set to Desired Squelch Setting (DSS)

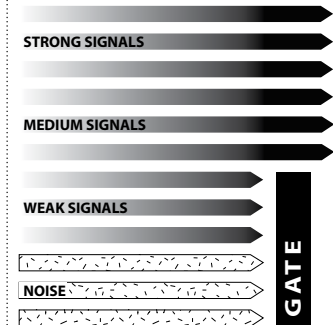

## To Transmit



### Caution!

Be sure the antenna is properly connected to the radio before transmitting. Prolonged transmitting without an antenna, or a poorly matched antenna, could cause damage to the transmitter.

Be sure to read the F.C.C. Rules and Regulations included with this unit before transmitting.

## Setting Dynamike

## To Transmit



- 1 Select desired channel.

## Setting Dynamike

This controls the microphone sensitivity (outgoing audio level).

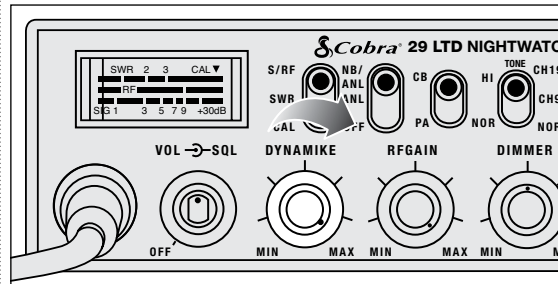

- 1 Initially, set fully clockwise so that maximum voice volume is available. Dynamike may have to be reduced in some conditions.

## Transmit

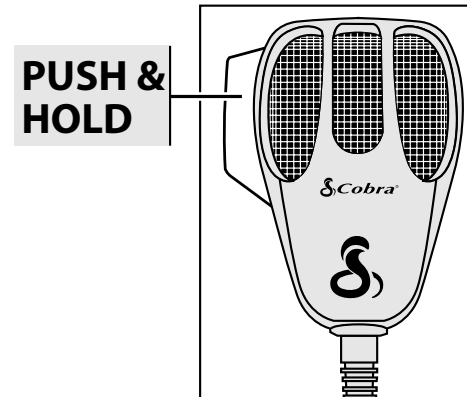

- 1 Push and hold mic button to transmit. Transmitter is now activated. When transmitting, hold the microphone two inches from your mouth and speak in a clear, normal voice. Release to receive.

## Transmit

## RF Meter

### RF Meter

This meter swings proportionately to the RF output (outgoing signal) while transmitting.

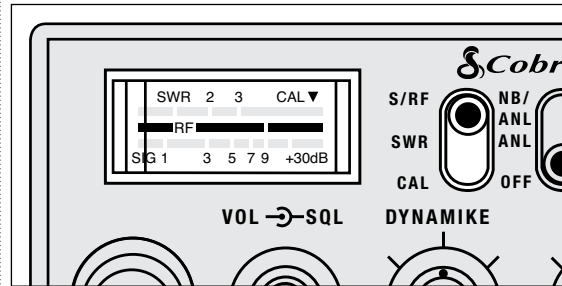

- 1 The S/R/F-SWR-CAL switch must be in the S/R/F position.

## External Speaker

The external speaker jack is used for remote receiver monitoring.

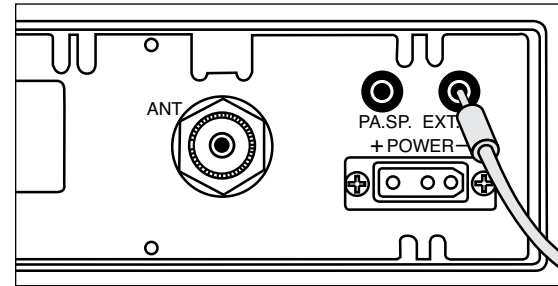

- 1 Connect an external speaker to the external speaker jack on the rear panel.

## External Speaker

### Note

The external speaker should have 8-ohm impedance and be rated to handle at least 4.0 Watts. When the external speaker is plugged in, the internal speaker is automatically disconnected.

### Note

Cobra external speakers are rated at 10 Watts.

## PA (Public Address)

### Note

Speaker should have 8-ohm impedance and be rated to handle at least 4.0 Watts.

### Note

The speaker should be directed away from the microphone to prevent acoustic feedback.

### Note

Activity on the CB channel will be heard through the PA speaker. Adjust Volume Control for normal listening level.

### PA (Public Address)

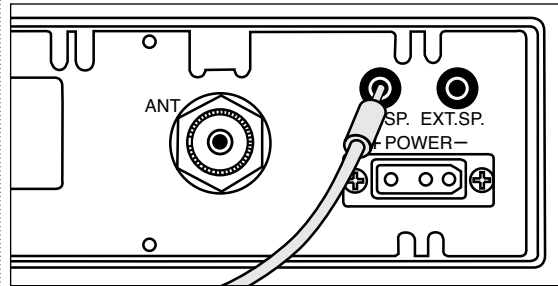

- 1 Connect an external PA speaker to the PA jack on the rear panel.

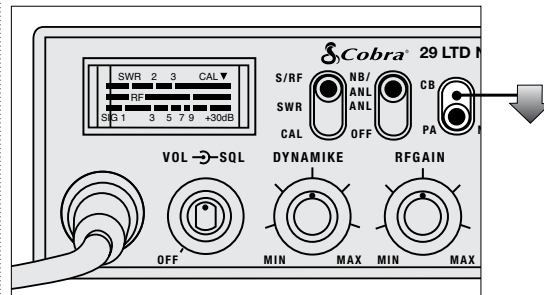

- 2 Set CB/PA switch to PA position.

**PUSH & HOLD**

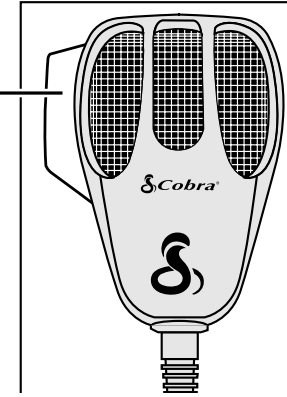

- 3 Push and hold microphone button and speak in a normal voice. Your voice will now transmit on the PA speaker.

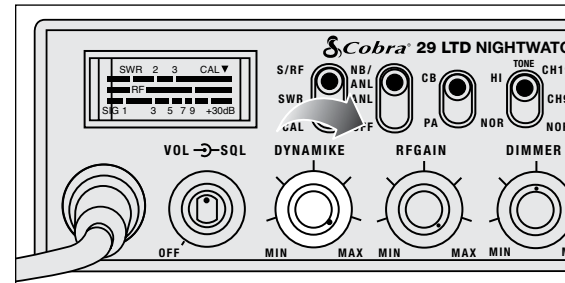

- 4 Adjust PA speaker volume with the Dynamike control.

# Home And Office Set-Up

## Base Station Operation (From 120V AC House Current)



**Warning!**  
Do not attempt to operate this transceiver by connecting it directly to 120 vac.

### Base Station Operation (From 120V AC House Current)

To operate your transceiver from home or office you will need a 13.8 volt DC Power Supply rated at a minimum of 2 amps, and a properly installed base station antenna.

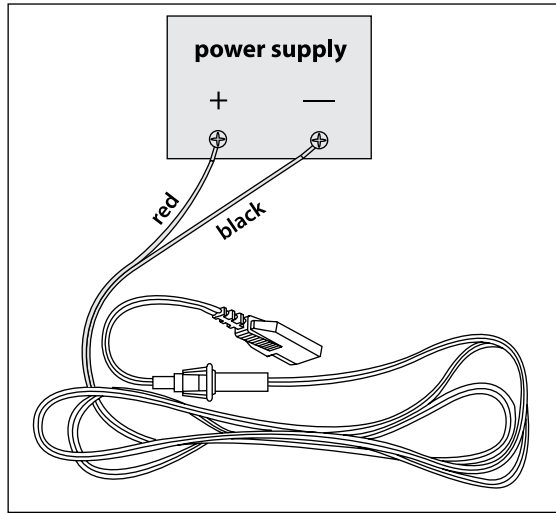

- 1 Simply connect the red (+) and black (-) leads of the transceiver to the corresponding terminals of the power supply.

# Temporary Mobile Set-Up

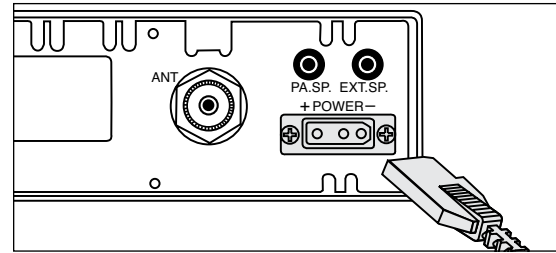

- 2 Plug power cable into back of unit marked "Power". Be sure to observe polarity markings.
- 3 Connect properly installed and matched base station antenna.

### Temporary Mobile Operation

For temporary mobile operation you may want to purchase an optional cigarette lighter adapter from your COBRA® dealer. This adapter and a magnetic mount antenna allow you to quickly "install" your transceiver for temporary use.

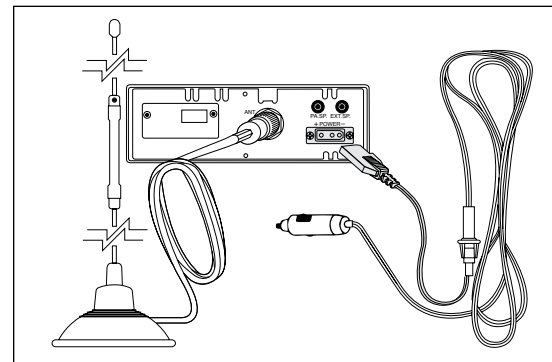

## Temporary Mobile Set-Up

## CB 10-Codes

Citizen Bands have adopted the "10-CODES" for standard questions and answers. These codes provide quick and easy communication, especially in noisy areas. Following are some of the more common codes and meanings:

### Code Meaning

10-1	Receiving poorly
10-2	Receiving well
10-3	Stop transmitting
10-4	OK, message received
10-5	Relay message
10-6	Busy, stand by
10-7	Out of service, leaving
10-8	In service, subject to call
10-9	Repeat message
10-10	Transmission completed standing by
10-11	Talking too rapidly
10-12	Visitors present
10-13	Advise weather/roads
10-16	Make pick up at
10-17	Urgent business
10-18	Anything for us?
10-19	Return to base
10-20	My location is
10-21	Call by phone
10-22	Report in person to
10-23	Stand by
10-24	Completed last assignment
10-25	Can you contact
10-26	Disregard last info
10-27	Moving to channel
10-28	Identify your station

### Code Meaning

10-29	Time is up for contact
10-30	Does not conform to FCC rules
10-33	Emergency traffic
10-34	Trouble at this station
10-35	Confidential information
10-36	Correct time is
10-37	Wrecker needed at
10-38	Ambulance needed
10-39	Message delivered
10-41	Turn to channel
10-42	Traffic accident at
10-43	Traffic tie up at
10-44	Have a message for
10-45	All units within range please report
10-50	Break channel
10-60	What is next message number?
10-62	Unable to copy. Use phone
10-63	Net directed to
10-64	Net clear
10-65	Awaiting your next message/assignment
10-67	All units comply
10-70	Fire at
10-71	Proceed, transmission in sequence
10-77	Negative contact
10-81	Reserve hotel room for
10-82	Reserve room for
10-85	My address is
10-91	Talk closer to mic
10-93	Check my frequency on this channel
10-94	Give me a long count
10-99	Mission completed, all units secure
10-200	Police needed at

# Frequency Ranges

The COBRA® 29 LTD NIGHTWATCH transceiver represents one of the most advanced AM two-way radios used as a Class D station in the Citizens Radio Service. This unit features advanced Phase Lock Loop (PLL) circuitry providing complete coverage of all 40 CB channels.

CB Channel	Channel Freq. In MHz	CB Channel	Channel Freq. In MHz
1	26.965	21	27.215
2	26.975	22	27.225
3	26.985	23	27.255
4	27.005	24	27.235
5	27.015	25	27.245
6	27.025	26	27.265
7	27.035	27	27.275
8	27.055	28	27.285
9	27.065	29	27.295
10	27.075	30	27.305
11	27.085	31	27.315
12	27.105	32	27.325
13	27.115	33	27.335
14	27.125	34	27.345
15	27.135	35	27.355
16	27.155	36	27.365
17	27.165	37	27.375
18	27.175	38	27.385
19	27.185	39	27.395
20	27.205	40	27.405

# 29 LTD NIGHTWATCH Specifications

## GENERAL

CHANNELS .....CB - 40 CH  
 FREQUENCY RANGE .....CB - 26.965 TO 27.405 MHZ  
 FREQUENCY TOLERANCE .....0.005 %  
 FREQUENCY CONTROL .....PLL (PHASE LOCK LOOP) SYNTHESIZER  
 OPERATING TEMPERATURE RANGE .....-30° C TO + 50° C  
 MICROPHONE .....PLUG-IN DYNAMIC  
 INPUT VOLTAGE .....13.8VDC nom. (negative ground)  
 CURRENT DRAIN TRANSMIT: AM FULL MOD., 1.5A (MAXIMUM)  
 RECEIVE: SQUELCHED, 0.3A;  
 FULL AUDIO OUTPUT, 1.2A (NOMINAL)  
 SIZE .....8-5/8" D X 7-9/32" W X 2-13/63" H  
 WEIGHT .....4 LBS.  
 ANTENNA CONNECTOR .....UHF; SO-239  
 METER .....ILLUMINATED; INDICATES RELATIVE POWER OUTPUT, RECEIVED SIGNAL STRENGTH AND VSWR

## TRANSMITTER

POWER OUTPUT .....4 WATTS  
 MODULATION .....AM (AMPLITUDE MODULATION)  
 FREQUENCY RESPONSE .....300 TO 3000 HZ  
 OUTPUT IMPEDANCE .....50 OHMS, UNBALANCED

## RECEIVER

SENSITIVITY .....LESS THAN 1 MV FOR 10dB (S+N) /N  
 SELECTIVITY .....6 dB @ 7 KHZ, 60 dB @ 10KHZ  
 IMAGE REJECTION .....80 dB, TYPICAL  
 ADJACENT-CHANNEL REJECTION ..60 dB, TYPICAL  
 IF FREQUENCIES .....DOUBLE CONVERSION: 1ST: 10.695 MHZ  
 2ND: 455 KHZ  
 AUTOMATIC GAIN CONTROL (AGC) LESS THAN 10 dB CHANGE IN AUDIO OUTPUT FOR INPUTS FROM 10 TO 50,000 MICROVOLTS  
 RF GAIN RANGE .....40 dB  
 NOISE BLANKER .....RF TYPE  
 SQUELCH .....ADJUSTABLE; THRESHOLD LESS THAN 1MV  
 AUDIO OUTPUT POWER .....4 WATTS  
 FREQUENCY RESPONSE .....300 TO 3000 HZ  
 DISTORTION .....LESS THAN 7% @3 WATTS @ 1000 HZ  
 BUILT-IN SPEAKER .....8 OHMS, 5W  
 EXTERNAL SPEAKER (NOT SUPPLIED) .8 OHMS; DISABLES INTERNAL SPEAKER WHEN CONNECTED

## PA SYSTEM

POWER OUTPUT .....4 WATTS INTO EXTERNAL SPEAKER  
 EXTERNAL SPEAKER FOR PA .....8 OHMS, 4 W MIN.  
 (NOT SUPPLIED) .....THE PA SPEAKER ALSO MONITORS THE RECEIVER; SEPARATE JACK PROVIDED

(SPECIFICATIONS SUBJECT TO CHANGE WITHOUT NOTICE)

# FCC Statement

## FCC Part 15.19 Warning Statement

THIS DEVICE COMPLIES WITH PART 15 OF THE FCC RULES. OPERATION IS SUBJECT TO THE FOLLOWING TWO CONDITIONS: (1) THIS DEVICE MAY NOT CAUSE HARMFUL INTERFERENCE, AND (2) THIS DEVICE MUST ACCEPT ANY INTERFERENCE RECEIVED, INCLUDING INTERFERENCE THAT MAY CAUSE UNDESIRE OPERATION.

## FCC Part 15.21 Warning Statement-

**NOTE:** THE GRANTEE IS NOT RESPONSIBLE FOR ANY CHANGES OR MODIFICATIONS NOT EXPRESSLY APPROVED BY THE PARTY RESPONSIBLE FOR COMPLIANCE. SUCH MODIFICATIONS COULD VOID THE USER'S AUTHORITY TO OPERATE THE EQUIPMENT.

## FCC Part 15.105(b) Warning Statement

**NOTE:** This equipment has been tested and found to comply with the limits for a Class B digital device, pursuant to part 15 of the FCC Rules. These limits are designed to provide reasonable protection against harmful interference in a residential installation. This equipment generates uses and can radiate radio frequency energy and, if not installed and used in accordance with the instructions, may cause harmful interference to radio communications. However, there is no guarantee that interference will not occur in a particular installation. If this equipment does cause harmful interference to radio or television reception, which can be determined by turning the equipment off and on, the user is encouraged to try to correct the interference by one or more of the following measures:

- Reorient or relocate the receiving antenna.
- Increase the separation between the equipment and receiver.
- Connect the equipment into an outlet on a circuit different from that to which the receiver is connected.
- Consult the dealer or an experienced radio/TV technician for help.

## IC RSS-GEN, Sec 8.4 Warning Statement

**ENGLISH:** This device complies with Industry Canada license-exempt RSS standard(s). Operation is subject to the following two conditions: (1) this device may not cause interference, and (2) this device must accept any interference, including interference that may cause undesired operation of the device.

**FRENCH:** Le présent appareil est conforme aux CNR d'Industrie Canada applicables aux appareils radio exempts de licence. L'exploitation est autorisée aux deux conditions suivantes : (1) l'appareil ne doit pas produire de brouillage, et (2) l'utilisateur de l'appareil doit accepter tout brouillage radioélectrique subi, même si le brouillage est susceptible d'en compromettre le fonctionnement.

## IC RSS-GEN, Sec 8.3 Warning Statement

**ENGLISH:** This radio transmitter (identify the device by certification number, or model number if Category II) has been approved by Industry Canada to operate with the antenna types listed below with the maximum permissible gain and required antenna impedance for each antenna type indicated. Antenna types not included in this list, having a gain greater than the maximum gain indicated for that type, are strictly prohibited for use with this device.

Immediately following the above notice, the manufacturer shall provide a list of all antenna types approved for use with the transmitter, indicating the maximum permissible antenna gain (in dBi) and required impedance for each.

**FRENCH:** Le présent émetteur radio (identifier le dispositif par son numéro de certification ou son numéro de modèle s'il fait partie du matériel de catégorie I) a été approuvé par Industrie Canada pour fonctionner avec les types d'antenne énumérés ci-dessous et ayant un gain admissible maximal et l'impédance requise pour chaque type d'antenne. Les types d'antenne non inclus dans cette liste, ou dont le gain est supérieur au gain maximal indiqué, sont strictement interdits pour l'exploitation de l'émetteur.

## RF Exposure Statement

**ENGLISH:** This equipment complies with FCC radiation exposure limits set forth for an uncontrolled environment. This equipment should be installed and operated with minimum distance 40cm between the radiator & your body.

The device is in compliance with RF exposure guidelines, users can obtain Canadian information on RF exposure and compliance. The minimum distance from body to use the device is 40cm.

**FRENCH:** Le présent appareil est conforme

Après examen de ce matériel aux conformité ou aux limites d'intensité de champ RF, les utilisateurs peuvent sur l'exposition aux radiofréquences et compliance d'acquérir les informations correspondantes. La distance minimale du corps à utiliser le dispositif est de 40cm.



# Limited Two Year Warranty

## Warranty Terms:

Cobra warrants your product against all defects in materials and workmanship for a period of two (2) years from the date of original purchase.

Cobra, at our sole discretion, will repair or replace your product (with the same or comparable product) free of charge.

Cobra will not pay shipping charges that you incur for sending your product to us. Products received COD will be refused.

To make a warranty claim, we will require proof of purchase in the form of an invoice or receipt. No proof of purchase is required for factory direct purchases.

**Warranty Exclusions:** Warranty does not apply to your product under any of the following conditions: 1. The serial number has been removed or modified. 2. Your product has been subjected to misuse or damage (including water damage, physical abuse, and/or improper installation). 3. Your product has been modified in any way. 4. Your receipt or proof-of-purchase is from a non-authorized dealer or internet auction site including E-bay, U-bid, or other non-authorized resellers.

**LIMITATION OF WARRANTY: EXCEPT AS EXPRESSLY PROVIDED HEREIN, YOU ARE ACQUIRING THE PRODUCT "AS IS" AND "WHERE IS", WITHOUT REPRESENTATION OR WARRANTY. COBRA SPECIFICALLY DISCLAIMS ANY REPRESENTATION OR WARRANTY INCLUDING, BUT NOT LIMITED TO THOSE CONCERNING THE MERCHANTABILITY AND SUITABILITY OF THE PRODUCT FOR A PARTICULAR PURPOSE. COBRA SHALL NOT BE LIABLE FOR CONSEQUENTIAL, SPECIAL OR INCIDENTAL DAMAGES INCLUDING, WITHOUT LIMITATION, DAMAGES ARISING OUT OF THE USE, MISUSE OR MOUNTING OF THE PRODUCT.**

The above limitations or exclusions shall be limited to the extent they violate the laws of any particular state. Cobra is not responsible for products lost in shipment between the owner and our service center.

## General Warranty Information

Each product we manufacture is covered by our factory warranty. While each product may have unique components and policy, the general guideline below will apply to most Cobra products.

All Cobra products purchased factory-direct or from our Authorized Resellers will come with a full one to three (1-3) year warranty from the date of the original retail purchase (see policy statement above for full warranty details and exclusions).

Standard accessories packaged with each model will have a one-year factory warranty.

Accessory items have a one-year factory warranty.

Shipping to our facility is not covered in our warranty. Return shipping is included within the US.

This warranty is non-transferrable.

For the sake of clarity, 'repair or replace the Product or its defective part' does not include removal or installation work, costs or expenses which include but are not limited to labor costs or expenses.

Cobra will not be responsible for lost packages.

# Product Service

If you have any questions about operation or installing your new Cobra product, PLEASE CONTACT COBRA FIRST...do not return this product to any retail store.

The contact information for Cobra will vary depending on the country in which you purchased and utilize the product. For the latest contact information, please go to [www.cobra.com/support](http://www.cobra.com/support)

For products purchased in the U.S.A. you may call 800-543-1608.

For products purchased in the U.S.A., if your product should require factory service, please go to [www.cobra.com/support](http://www.cobra.com/support) and follow the instructions for returning your product to the Cobra Factory Service Department for service.

Should there be any problems with this product or further information is needed on its features please visit [www.cobra.com](http://www.cobra.com) for support, frequently asked questions, Declarations of Conformity, and full manuals.

## For Products Purchased Outside the U.S.A. or Canada

Please contact your local dealer for product service information.

## For Products Used in Canada Industry Canada Notice

This device complies with Industry Canada license-exempt RSS standard(s). Operation is subject to the following two conditions:

- (1) this device may not cause interference, and
- (2) this device must accept any interference, including interference that may cause undesired operation of the device.

Le présent appareil est conforme aux CNR d'Industrie Canada applicables aux appareils radio exempts de licence. L'exploitation est autorisée aux deux conditions suivantes:

- (1) l'appareil ne doit pas produire de brouillage, et
- (2) l'utilisateur de l'appareil doit accepter tout brouillage radioélectrique subi, même si le brouillage est susceptible d'en compromettre le fonctionnement.



# 29 LTD NIGHTWATCH®

Professional CB Radio  
Always Visible, Day or Night



For more information or to order any of our products, please visit our website: [www.cobra.com](http://www.cobra.com)

©2021 Cobra Electronics Corporation

Cobra®, Dynamike®, Nightwatch®, Nothing Comes Close to a Cobra® and the snake design are registered trademarks of Cobra Electronics Corporation, USA.

Cobra Electronics Corporation™ is a trademark of Cobra Electronics Corporation, USA.

Pat. [www.cobra.com/patents](http://www.cobra.com/patents)

OWNER'S MANUAL

Nothing Comes Close to a Cobra®

## The CB Story

The Citizens Band lies between the shortwave broadcast and 10-meter Amateur radio bands, and was established by law in 1949. The Class D two-way communications service was opened in 1959. (CB also includes a Class A citizens band and Class C remote control frequencies.)

**Federal Communications FCC Regulations**  
FCC regulations permit only "transmissions" (one party to another) rather than "broadcasts" (to a wide audience). Thus, advertising is not allowed on CB Channels because that is "broadcasting."

### FCC Warnings

All transmitter adjustments other than those supplied by the manufacturer as front panel operating controls, must be made by, or under the supervision of, the holder of an FCC-issued general Radio-Telephone Operator's License.

Replacement or substitution of transistors, regular diodes or other parts of a unique nature, with parts other than those recommended by Cobra, may cause violation of the technical regulations of Part 95 of the FCC Rules, or violation of Type Acceptance requirements of Part 2 of the Rules.

### What's Included with Your 29 LTD NIGHTWATCH

- 1 CB Transceiver
- 2 Microphone
- 3 Transceiver Bracket
- 4 Microphone Bracket
- 5 DC Power Cord
- 6 Operating Manual

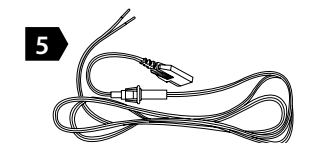
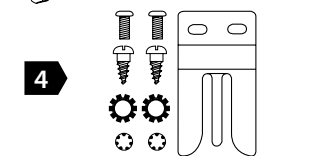
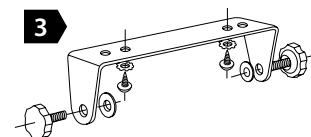
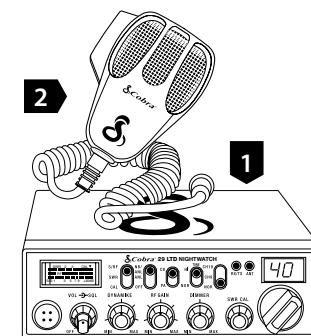

# Controls and Indicators

# Our Thanks to You

# Ordering Info

1. 4-Pin Microphone Connector
2. Power On/Off, Volume
3. Squelch
4. Dynamike
5. RF Gain
6. Dimmer
7. SWR CAL
8. Channel Selector
9. LED Channel Display
10. ANT Warning LED
11. RX (Receive)/ TX (Transmit) LED Indicator
12. Channel 19/Channel 9/ Normal Switch
13. Tone Hi/Nor
14. CB/PA Switch
15. NB/ANL ANL Off Switch
16. S/RF SWR CAL Switch
17. Signal Strength Meter
18. Microphone

### Back Side

19. Public Address Speaker Jack
20. External Speaker Jack
21. Antenna Connector
22. Power Jack

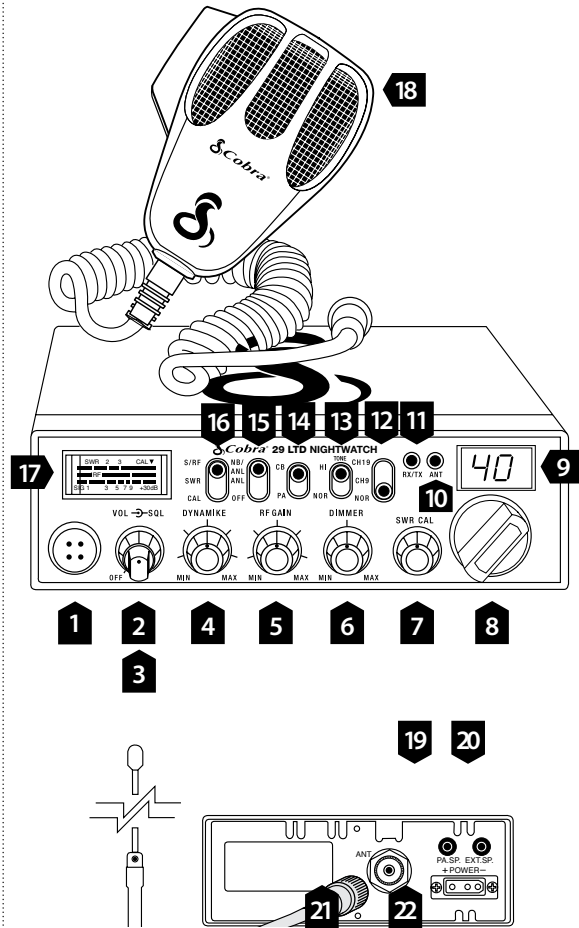

Thank you for purchasing the Cobra® 29 LTD NIGHTWATCH CB Radio. Properly used, this Cobra® product will give you many years of reliable service.

### Customer Support

Should you encounter any problems with the product or not understand its many features, please refer to this owner's manual. If, after referring to the manual, you still need help, call Cobra Customer Service at 800-543-1608.

### Cobra Assistance

Should you encounter any problems with this product, or not understand its many features, please refer to this owner's manual. If you require further assistance after reading this manual, Cobra Electronics offers the following customer assistance services:

**Monday-Friday 9:00 AM-5:00 PM EST**

Call: 8800-543-1608

### SERVICE

Monday-Thursday

9:00AM-5:00PM EST

Call: 800-543-1608

### Office:

6500 West Cortland Street,  
Chicago, IL, 60707

### Have questions? We can help.

Contact us at 800-543-1608

M-F 9:00AM-5PM EST

### For Assistance Outside the U.S.A.

Contact Your Local Dealer

You can find quality Cobra products and accessories at your local Cobra dealer, or in the U.S.A., you can order directly from Cobra.

### Please visit [www.cobra.com](http://www.cobra.com)

Web orders will normally ship the next business day if received by us before 2:00 PM Eastern Time. Orders do not ship on weekends or holidays. All standard deliveries are Monday-Friday only. Saturday delivery can be requested in certain areas of the country for an additional shipping fee by calling Sales at 800-543-1608.

Certain orders may require additional days to process prior to shipping. Holidays may also impact processing and shipping time frame. Occasionally, items may not ship due to inventory depletion. If you need your item to be expedited, we recommend calling Sales at 800-543-1608.

### Order Acceptance

Once your order has been accepted and processed, you will receive an email that will include the shipping carrier and tracking information.

### Shipping and Delivery

Free ground shipping is included to 48 states. Hawaii, Alaska and Puerto Rico ship based on assessed fee at checkout.

We require a physical address for shipping. Sorry, no P.O. Boxes or APO/FPO addresses. Please select 2-day or next day air for shipments to Hawaii or Alaska. Shipping charges are calculated on a per-product basis. Please make note of the shipping charges associated with each item.

**Note:** For safety reasons, we cannot ship products containing lithium-ion batteries via air delivery methods. These items are available to ship via ground service only.

**Note:** For your protection, some orders may require a signature for delivery.